

Ring terminal 0.25 - 6 mm²

B4643R

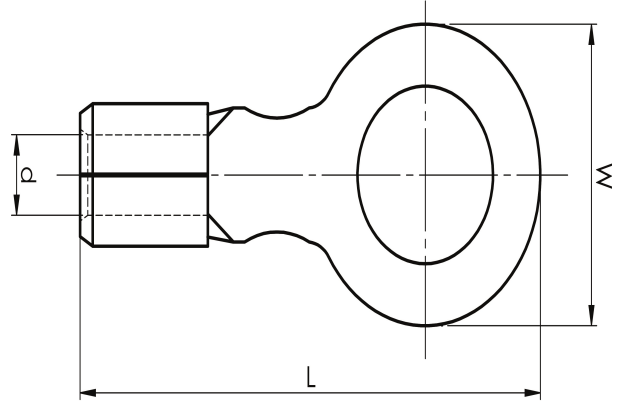

Item number: **7258-262100**

EAN: **7393487003897**

W (mm): **7.8**

d (mm): **3.4**

L (mm): **17.5**

t (mm) - palm thickness: **1**

s (mm) - strip length: **9**

Screw: **M4**

Neck type: **Brazed**

AWG/MCM Cu: **12 - 10 AWG**

mm² Cu: **4-6**