

KRT tube terminals 10 - 500 mm²

KRT70-8

- ✓ Material: Cu 99.95%, tin plated Cu/Sn.
- ✓ Inspection hole.
- ✓ For stranded (class 2) Cu conductors.

Example of marking KRT: 16 (neck) Elpress logotype 70 10 (palm)

16 = Die No. 70 = mm² 10 = palm hole for M10
Tube terminal type KRT for stranded (class 2) Cu
conductors, 70 mm², with an M8 hole in the palm.
Used with Elpress certified systems V600, V1300 or
V250.

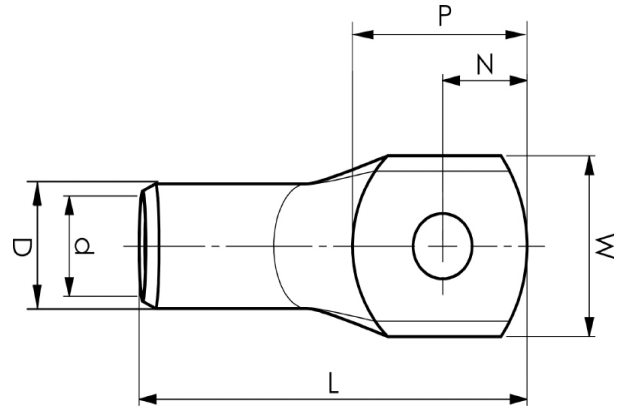

Item number: **7301-277300**
EAN: **7393487007581**

W (mm): **23**
N (mm): **11**
N1 (mm): **11**
P (mm): **22**
d (mm): **12**
D (mm): **16**
L (mm): **55**
t (mm) - palm thickness: **3.9**
s (mm) - strip length: **23**

Screw: **M8**
Inspection hole: **Yes**

AWG/MCM Cu: **2/0 AWG**
mm² Cu: **70**