

KRT tube terminals 10 - 500 mm²

KRT400-20

- ✓ Material: Cu 99.95%, tin plated Cu/Sn.
- ✓ Inspection hole.
- ✓ For stranded (class 2) Cu conductors.

Example of marking KRT: 16 (neck) Elpress logotype 70 10 (palm)

16 = Die No. 70 = mm² 10 = palm hole for M10

Tube terminal type KRT for stranded (class 2) Cu
conductors, 400 mm², with an M20 hole in the palm.

Used with Elpress certified systems V1300 or V250.

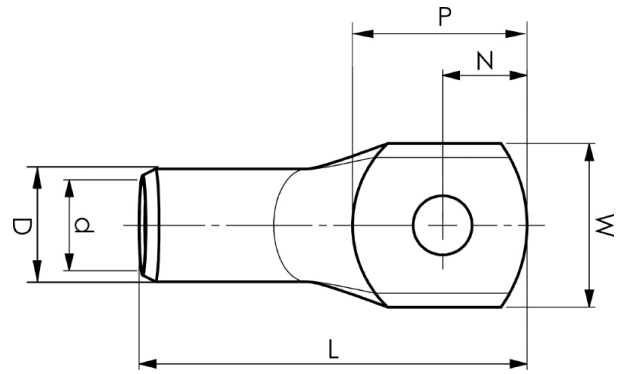

**UK
CA**

Item number: **7301-279700**

EAN: **7393487007826**

W (mm): **48**

N (mm): **22**

N1 (mm): **31**

P (mm): **53**

d (mm): **26**

D (mm): **32**

L (mm): **116**

t (mm) - palm thickness: **5.8**

s (mm) - strip length: **44**

Screw: **M20**

Inspection hole: **Yes**

AWG/MCM Cu: **700 MCM**

mm² Cu: **400**

ELPRESS