

KRT tube terminals 10 - 500 mm²

KRT300-12

- ✓ Material: Cu 99.95%, tin plated Cu/Sn.
- ✓ Inspection hole.
- ✓ For stranded (class 2) Cu conductors.

Example of marking KRT: 16 (neck) Elpress logotype 70 10 (palm)

16 = Die No. 70 = mm² 10 = palm hole for M10
Tube terminal type KRT for stranded (class 2) Cu
conductors, 300 mm², with an M12 hole in the palm.
Used with Elpress certified systems V1300 or V250.



**UK
CA**

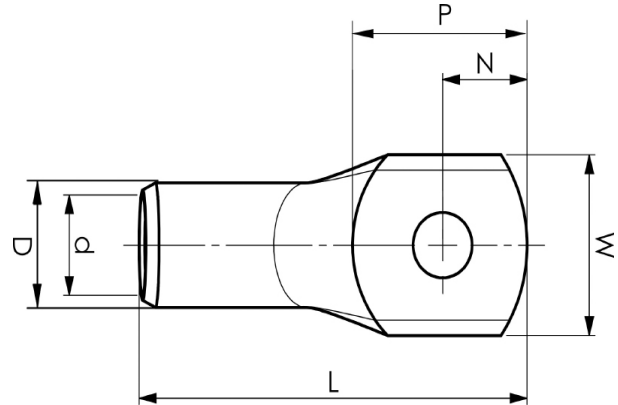

Item number: **7301-279300**

EAN: **7393487007789**

W (mm): **44**

N (mm): **19**

N1 (mm): **19**

P (mm): **38**

d (mm): **24**

D (mm): **30**

L (mm): **100**

t (mm) - palm thickness: **5.8**

s (mm) - strip length: **42**

Screw: **M12**

Inspection hole: **Yes**

AWG/MCM Cu: **550 MCM**

mm² Cu: **300**

ELPRESS