

KRF tube terminals with two holes

KRF25-8X2- 40

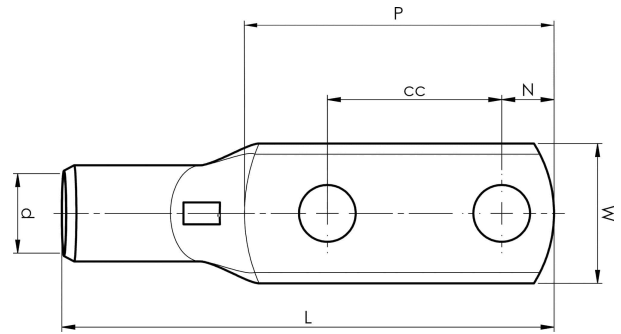

- ✓ Material: Cu 99.95%, tin plated Cu/Sn.
- ✓ Inspection hole
- ✓ For stranded (class 2) and multi-stranded (class 5) Cu conductors, for multi-stranded Cu conductors contact crimping using the Dual system is recommended.
- ✓ UL-approved.

Example of marking KRF: 17 (neck) Elpress logotype 70 10F (palm)

17 = Die No. 70 = mm² 10 = palm hole for M10 F = type KRF for stranded and flexible conductors.
2 holed tube terminal for multi-stranded (class 5) and stranded (class 2) Cu-conductors (acc. to IEC 60228), 25 mm², with two M8 holes in the palm.
Used with Elpress certified systems V600, V1300 or V250.



Item number: **7301-465700**

EAN: **7393487011083**

W (mm): **16**

N (mm): **9.5**

N1 (mm): **10.5**

P (mm): **60**

cc (mm): **40**

f (mm): **1**

d (mm): **8**

D (mm): **11**

L (mm): **83**

t (mm) - palm thickness: **2.9**

s (mm) - strip length: **13**

Screw: **M8x2**

Inspection hole: **Yes**

AWG/MCM Cu: **4 AWG**

mm² Cu: **25**

ELPRESS