

KRD tube terminals 16 - 1000 mm²

KRD25-6

- ✓ Material: Cu 99.95%, tin plated Cu/Sn.
- ✓ Inspection hole.
- ✓ For stranded (class 2) Cu conductors.

Example of marking KRD: 14 (neck) Elpress logotype 70 10 (palm)

14 = Die No. 70 = mm² 10 = palm hole for M10
Tube terminal type KRD for stranded (class 2) Cu
conductors, 25 mm², with an M6 hole in the palm.
Used with Elpress certified systems V600, V1300 or
V250.

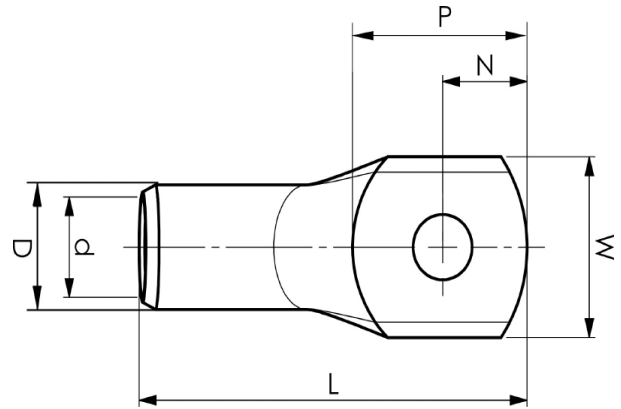

Item number: **7301-100500**
EAN: **7393487006676**

W (mm): **13**
N (mm): **7**
N1 (mm): **9**
P (mm): **16**
f (mm): **1**
d (mm): **6.7**
D (mm): **9**
L (mm): **32**
t (mm) - palm thickness: **2.2**
s (mm) - strip length: **10**

Screw: **M6**
Inspection hole: **Yes**

AWG/MCM Cu: **4 AWG**
mm² Cu: **25**