

DIN 46234 sheet metal terminals 10 - 185 mm²

B35-12R

- dimensions according to DIN 46234
- material: 99.9% Cu, tin plated (Cu/Sn)

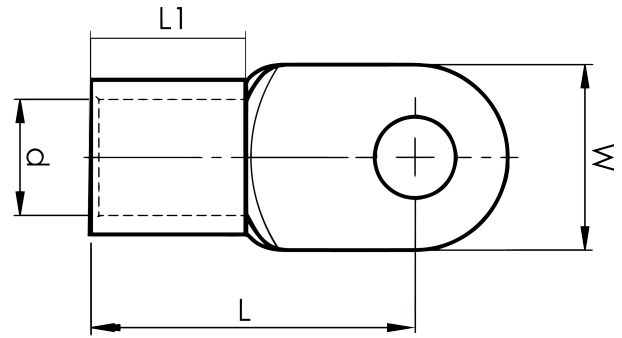

Sheet metal terminal for 35 mm² copper conductors with an M12 hole in the palm. Used with Elpress certified systems V600, V1300 or V250.



Item number: **7258-267400**
EAN: **7393487018648**

W (mm): **22**
d (mm): **9**
L1 (mm): **12**
L (mm): **31**
t (mm) - palm thickness: **1.6**

Screw: **M12**
Marking: **35**

AWG/MCM Cu: **2 AWG**
mm² Cu: **35**