

Pre-insulated TWIN-end terminals 2 x 0.5 - 2 x 10 mm², ET2, standard colour code

A4-18ET2

- ✓ Material: Cu 99.95%, tin plated Cu/Sn, CSA approved.
- ✓ Polypropylene insulation, colour code acc. to DIN46228.

Pre-insulated TWIN end terminal ET2, 4 mm². Used with certified tool GEB4010C-TWIN, EEB0160, or PEB0110T.

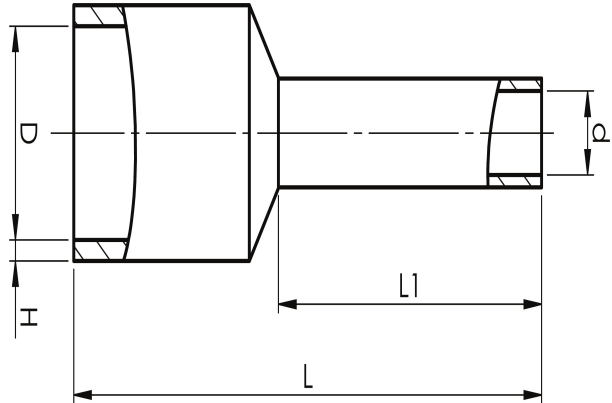
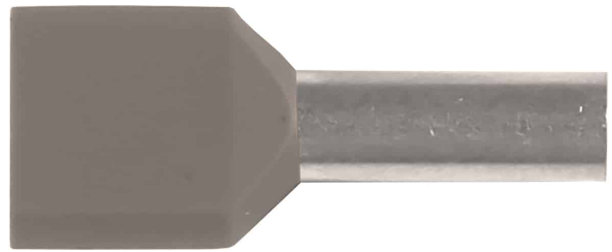

Item number: **7287-011000**

EAN: **7393487046368**

H (mm): **4.9**

d (mm): **3.8**

D (mm): **8,6**

L1 (mm): **18**

L (mm): **29**

s (mm) - strip length: **20**

Working temperature, Min (°C): **-5**

Working temperature, Max (°C): **105**

Insulation material: **PP**

Insulation colour: **Grey (end sleeves)**

Material: **Cu, Cu/Sn**

AWG/MCM Cu: **2x12 AWG**

mm² Cu: **2 x 4**