

Pre-insulated TWIN-end terminals 2 x 0.5 - 2 x 10
mm², ET2, standard colour code

A0,5-6ET2

- ✓ Material: Cu 99.95%, tin plated Cu/Sn, CSA approved.
- ✓ Polypropylene insulation, colour code acc. to DIN46228.

Pre-insulated TWIN end terminal ET2, 0.5 mm².
Used with certified tool PEB0110T.

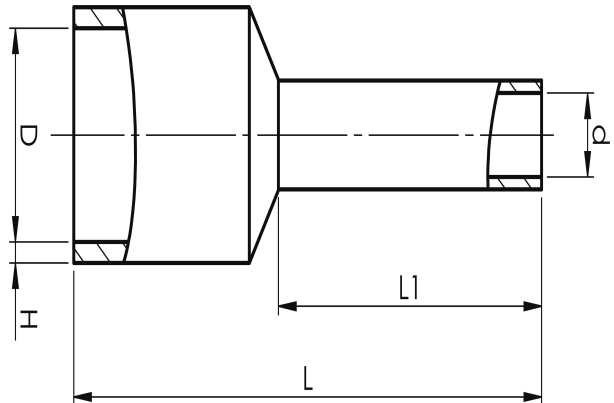
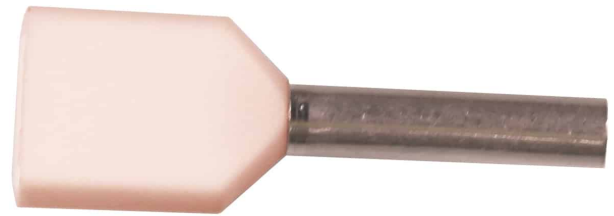

Item number: **7287-010600**

EAN: **7393487045903**

H (mm): **2.3**

d (mm): **1.5**

D (mm): **4,5**

L1 (mm): **6**

L (mm): **13**

s (mm) - strip length: **8**

Working temperature, Min (°C): **-5**

Working temperature, Max (°C): **105**

Insulation material: **PP**

Insulation colour: **White (end sleeves)**

Material: **Cu, Cu/Sn**

AWG/MCM Cu: **2x20 AWG**

mm² Cu: **2 x 0,5**