

Pre-insulated end terminals 0.14 - 95 mm² ETD,
alternative colour

A1-8ETD

- ✓ Material: Cu 99.95%, tin plated Cu/Sn, CSA approved.
- ✓ Polypropylene insulation, colour code DIN46228.

Pre-insulated end terminal ETD, 1 mm². Used with certified tool PEB0110T.

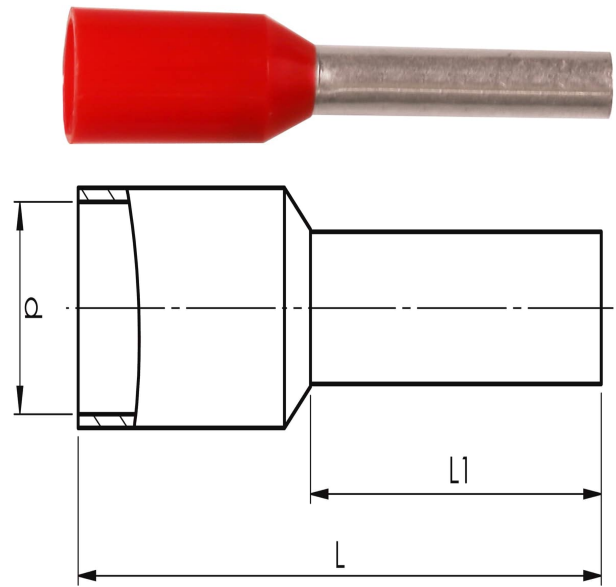

Item number: **7287-012300**
EAN: **7393487021617**

d (mm): **3**
L1 (mm): **8**
L (mm): **14**
s (mm) - strip length: **10**

Working temperature, Min (°C): **-5**
Working temperature, Max (°C): **105**
Insulation material: **PP**
Insulation colour: **Red (end sleeves)**
Material: **Cu, Cu/Sn**

AWG/MCM Cu: **18 AWG**
mm² Cu: **1**