

KRT tube terminals 10 - 500 mm<sup>2</sup>

# KRT500-14

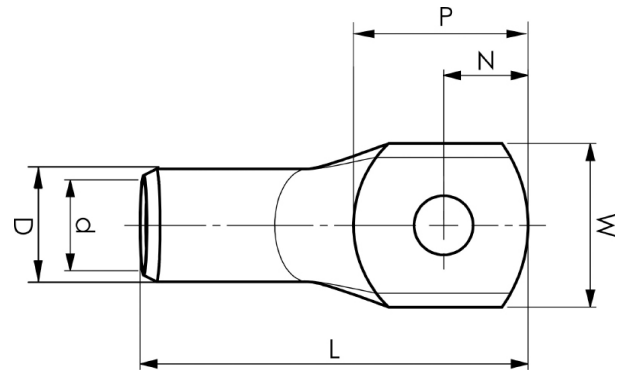

Item number: **7301-280500**

EAN: **7393487089440**

W (mm): **58**

N (mm): **25**

N1 (mm): **35**

P (mm): **60**

d (mm): **31**

D (mm): **40**

L (mm): **150**

t (mm) - palm thickness: **8.8**

s (mm) - strip length: **70**

Screw: **M14**

Inspection hole: **Yes**

AWG/MCM Cu: **950 MCM**

mm<sup>2</sup> Cu: **500**