

KRD tube terminals 16 - 1000 mm²

KRD95-14

- ✓ Material: Cu 99.95%, tin plated Cu/Sn.
- ✓ Inspection hole.
- ✓ For stranded (class 2) Cu conductors.

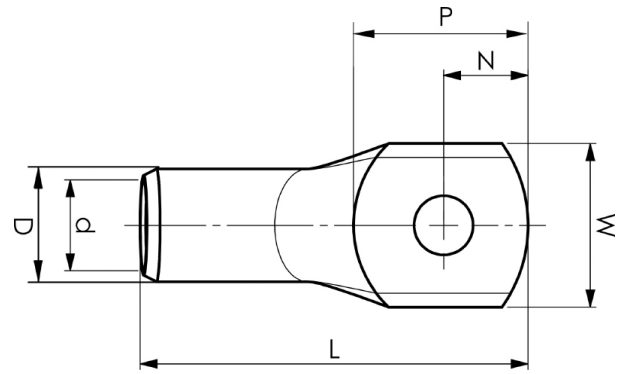

Example of marking KRD: 14 (neck) Elpress logotype 70 10 (palm)

14 = Die No. 70 = mm² 10 = palm hole for M10

Tube terminal type KRD for stranded (class 2) Cu
conductors, 95 mm², with an M14 hole in the palm.

Used with Elpress certified systems V600, V1300 or
V250.



Item number: **7301-101800**

EAN: **7393487089679**

W (mm): **24**

N (mm): **12**

N1 (mm): **13**

P (mm): **25**

f (mm): **1**

d (mm): **13**

D (mm): **16**

L (mm): **61**

t (mm) - palm thickness: **2.8**

s (mm) - strip length: **26**

Screw: **M14**

Inspection hole: **Yes**

AWG/MCM Cu: **3/0 AWG**

mm² Cu: **95**