

KRD tube terminals 16 - 1000 mm²

KRD630-24

- ✓ Material: Cu 99.95%, tin plated Cu/Sn.
- ✓ Inspection hole.
- ✓ For stranded (class 2) Cu conductors.

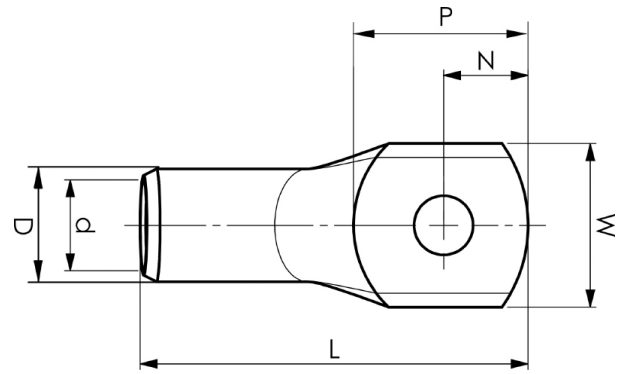

Example of marking KRD: 14 (neck) Elpress logotype 70 10 (palm)

14 = Die No. 70 = mm² 10 = palm hole for M10
Tube terminal type KRD for stranded (class 2) Cu
conductors, 630 mm², with an M24 hole in the palm.
Used with Elpress certified systems V250 or V1470.



Item number: **7301-107900**

EAN: **7393487086135**

W (mm): **65**

N (mm): **25**

N1 (mm): **35**

P (mm): **60**

f (mm): **1.5**

d (mm): **34**

D (mm): **45**

L (mm): **150**

t (mm) - palm thickness: **10.8**

s (mm) - strip length: **70**

Screw: **M24**

Inspection hole: **Yes**

AWG/MCM Cu: **1250 MCM**

mm² Cu: **630**