

KRD tube terminals 16 - 1000 mm<sup>2</sup>

# KRD185-8

- ✓ Material: Cu 99.95%, tin plated Cu/Sn.
- ✓ Inspection hole.
- ✓ For stranded (class 2) Cu conductors.

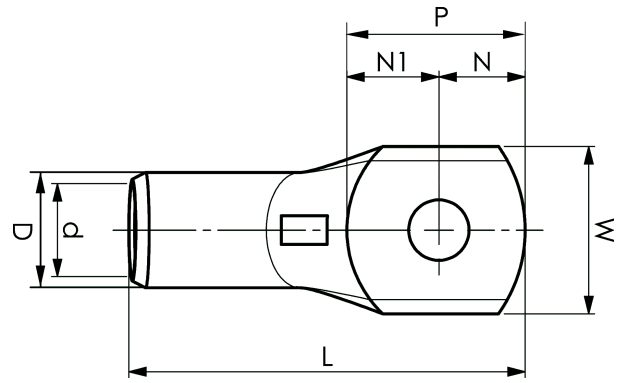

## Example of marking KRD: 14 (neck) Elpress logotype 70 10 (palm)

14 = Die No. 70 = mm<sup>2</sup> 10 = palm hole for M10  
Tube terminal type KRD for stranded (class 2) Cu  
conductors, 185 mm<sup>2</sup>, with an M8 hole in the palm.  
Used with Elpress certified systems V600, V1300 or  
V250.



Item number: **7301-511400**  
EAN: **7393487089426**

W (mm): **36**  
N (mm): **15**  
N1 (mm): **16**  
P (mm): **31**  
f (mm): **1**  
d (mm): **19**  
D (mm): **25**  
L (mm): **80**  
t (mm) - palm thickness: **5.9**  
s (mm) - strip length: **32**

Screw: **M8**  
Inspection hole: **Yes**

AWG/MCM Cu: **350 MCM**  
mm<sup>2</sup> Cu: **185**