

DIN 46234 sheet metal terminals 10 - 185 mm<sup>2</sup>

# B16-6R

- ✓ dimensions according to DIN 46234
- ✓ material: 99.9% Cu, tin plated (Cu/Sn)

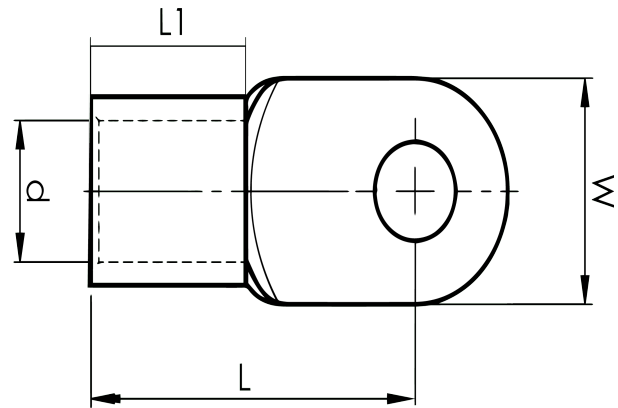

Sheet metal terminal for 16 mm<sup>2</sup> copper conductors with an M6 hole in the palm. Used with Elpress certified systems V600, V1300 or V250.



Item number: **7258-266100**  
EAN: **7393487018518**

W (mm): **11**  
d (mm): **5.8**  
L1 (mm): **10**  
L (mm): **20**  
t (mm) - palm thickness: **1.2**

Screw: **M6**  
Marking: **16**

AWG/MCM Cu: **6 AWG**  
mm<sup>2</sup> Cu: **16**