

Aluminium-copper terminals 16 - 1200 mm²

AKK185-12

- ✓ Used for connection of Al conductors for apparatus outlets and busbars of Cu.
- ✓ Two crimps are needed.

AlCu terminal for stranded Al cable 185 mm², or for solid Al cable 240 mm², with an M12 hole in the palm. Used with Elpress certified systems V1300, V250.

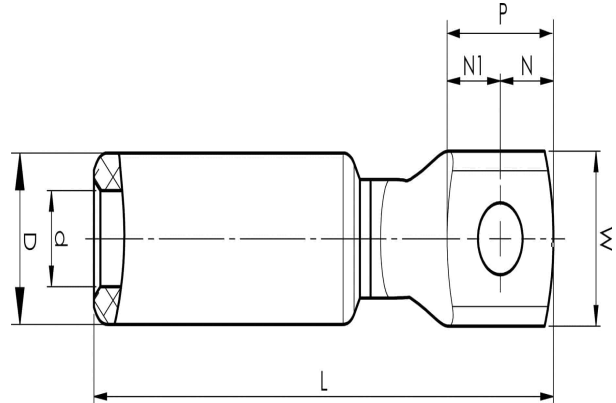

Item number: **7331-403500**

EAN: **7393487009516**

W (mm): **30**

N (mm): **15**

N1 (mm): **15**

P (mm): **30**

d (mm): **17.6**

D (mm): **32**

L (mm): **116**

t (mm) - palm thickness: **6.5**

s (mm) - strip length: **60**

Screw: **M12**

AWG/MCM Stranded Al: **350 MCM**

AWG/MCM Solid Al: **450 MCM**

mm² Stranded Al: **185**

mm² Solid Al: **240**