

Aluminium terminals 16 - 1200 mm²

AK95-10

- ✓ Used for connecting Al conductors to Al busbar.
- ✓ Two crimps are needed.

Al terminal for stranded Al cable 95 mm², or for solid Al cable 120 mm² with an M10 hole in the palm. Used with Elpress certified systems V1300 or V250.

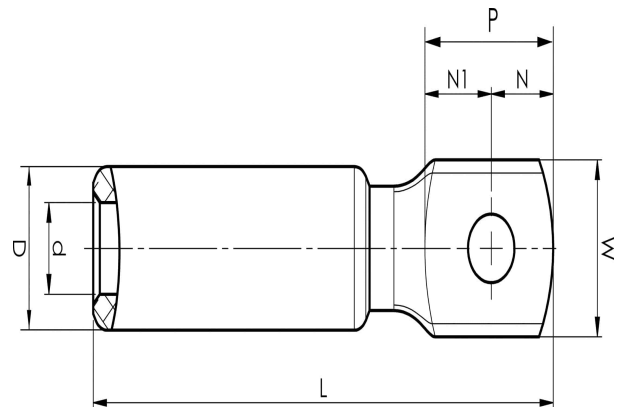

Item number: **7311-402200**
EAN: **7393487008816**

W (mm): **27**
N (mm): **14**
N1 (mm): **15**
P (mm): **29**
d (mm): **12.5**
D (mm): **25**
L (mm): **104**
t (mm) - palm thickness: **10.5**
s (mm) - strip length: **60**

Screw: **M10**

AWG/MCM Stranded Al: **3/0 AWG**
AWG/MCM Solid Al: **4/0 AWG**
mm² Stranded Al: **95**
mm² Solid Al: **120**