

KRD tube terminals 16 - 1000 mm<sup>2</sup>

# KRD185-00

- ✓ Material: Cu 99.95%, tin plated Cu/Sn.
- ✓ Inspection hole.
- ✓ For stranded (class 2) Cu conductors.

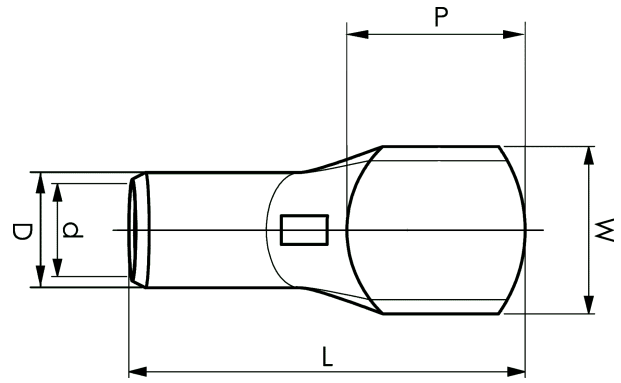

## Example of marking KRD: 14 (neck) Elpress logotype 70 10 (palm)

14 = Die No. 70 = mm<sup>2</sup> 10 = palm hole for M10

Tube terminal type KRD for stranded (class 2) Cu conductors, 185 mm<sup>2</sup>, without a hole in the palm.

Used with Elpress certified systems V600, V1300 or V250.



Item number: **7301-440300**

EAN: **7393487007185**

W (mm): **36**

P (mm): **38**

f (mm): **1**

d (mm): **19**

D (mm): **25**

L (mm): **87**

t (mm) - palm thickness: **5.9**

s (mm) - strip length: **32**

Inspection hole: **Yes**

AWG/MCM Cu: **350 MCM**

mm<sup>2</sup> Cu: **185**