

Aluminium-copper terminals 16 - 1200 mm²

AKK50-8

- ✓ Used for connection of Al conductors for apparatus outlets and busbars of Cu.
- ✓ Two crimps are needed.

AlCu terminal for stranded Al cable 50 mm², or for solid Al cable 70 mm², with an M8 hole in the palm.
Used with Elpress certified systems V1300, V250.

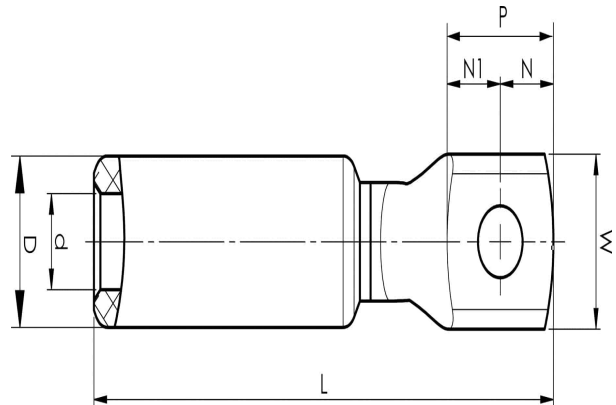

Item number: **7331-401300**

EAN: **7393487009356**

W (mm): **25**

N (mm): **12.5**

N1 (mm): **12.5**

P (mm): **25**

d (mm): **9.6**

D (mm): **20**

L (mm): **89**

t (mm) - palm thickness: **5.8**

s (mm) - strip length: **45**

Screw: **M8**

AWG/MCM Stranded Al: **1/0 AWG**

AWG/MCM Solid Al: **2/0 AWG**

mm² Stranded Al: **50**

mm² Solid Al: **70**