

Tube terminals with two stud holes (one oval) 50 -
240 mm²

KRF120- 10X2-24-26L

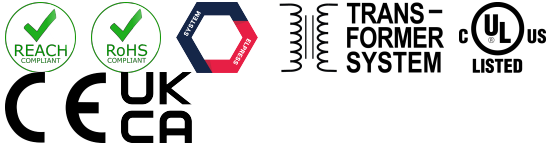
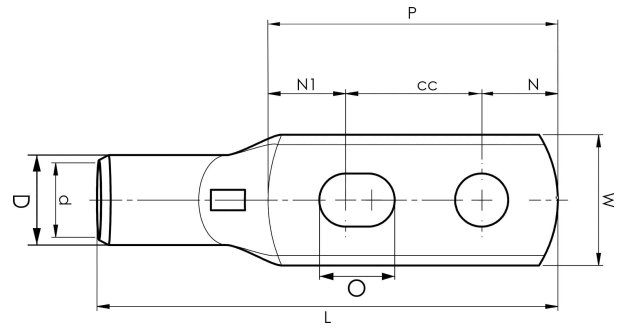

Item number: **7301-528400**
EAN: **7393487063327**

W (mm): **32**
N (mm): **11**
N1 (mm): **19**
P (mm): **55**
cc (mm): **25**
O (mm): **12.5**
d (mm): **17**
D (mm): **22**
L (mm): **97**
t (mm) - palm thickness: **4.9**
s (mm) - strip length: **27**

Screw: **M10x2**
Inspection hole: **Yes**

AWG/MCM Cu: **4/0 AWG**
mm² Cu: **120**
Winding (mm²): **145-185**