

Tube terminals 0.75 - 10 mm<sup>2</sup>

# KR2,5-4

- ✓ Material: Cu 99.95%, tin plated Cu/Sn.
- ✓ For multi-stranded (class 5) and stranded (class 2) Cu conductors.
- ✓ UL approved.
- ✓ Without inspection hole.

## Examples of palm marking KR: 10-10

10 = mm<sup>2</sup> 10 = Palm hole for M10

Tube terminal for multi-stranded (class 5) and stranded (class 2) Cu-conductors (acc. to IEC 60228), 2.5 mm<sup>2</sup>, with an M4 hole in the palm. Used with certified tool DKB0325, DKB0760.

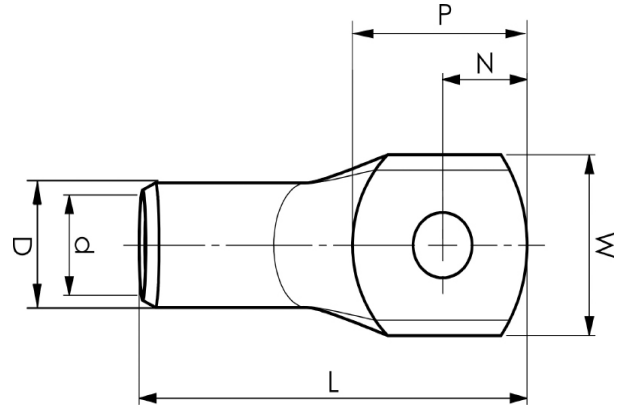

Item number: **7301-010600**

EAN: **7393487005785**

W (mm): **7.5**

N (mm): **4.2**

N1 (mm): **4.1**

P (mm): **8.3**

d (mm): **2.3**

D (mm): **4.2**

L (mm): **18**

t (mm) - palm thickness: **1.3**

s (mm) - strip length: **7**

Screw: **M4**

AWG/MCM Cu: **14 AWG**

mm<sup>2</sup> Cu: **2,5**