

KRT tube terminals 10 - 500 mm²

KRT10-6

- ✓ Material: Cu 99.95%, tin plated Cu/Sn.
- ✓ Inspection hole.
- ✓ For stranded (class 2) Cu conductors.

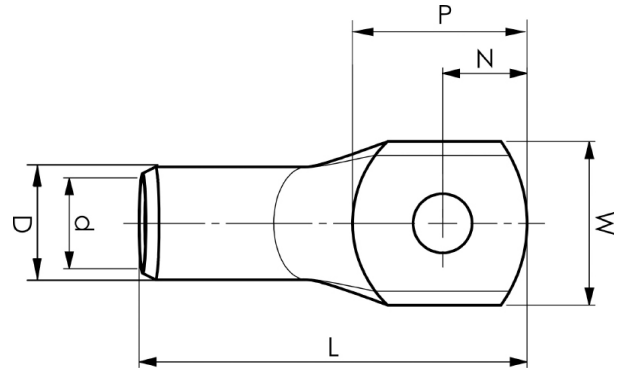

Example of marking KRT: 16 (neck) Elpress logotype 70 10 (palm)

16 = Die No. 70 = mm² 10 = palm hole for M10

Tube terminal type KRT for stranded (class 2) Cu conductors, 10 mm², with an M6 hole in the palm.

Used with Elpress certified systems V600, V1300 or V250.



Item number: **7301-275200**

EAN: **7393487007376**

W (mm): **10**

N (mm): **6**

N1 (mm): **8**

P (mm): **14**

d (mm): **4.5**

D (mm): **7**

L (mm): **29**

t (mm) - palm thickness: **2.4**

s (mm) - strip length: **11**

Screw: **M6**

Inspection hole: **Yes**

AWG/MCM Cu: **8 AWG**

mm² Cu: **10**