

KRFS tube terminals 50 - 400 mm² with narrow palm

KRFS70-6

- ✓ Material: Cu 99.95%, tin plated Cu/Sn.
- ✓ Inspection hole
- ✓ For stranded (class 2) and multi-stranded (class 5) Cu conductors, for multi-stranded Cu conductors contact crimping using the Dual system is recommended.
- ✓ Easy to install via cable gland, allows for pre-installation.
- ✓ The width of the palm is less than or as wide as the neck.

Example of marking KRFS: 17 (neck) Elpress logotype 70 10F (palm)

17 = Die no. 70 = mm² 10 = palm hole for M10 F = type KRF for stranded and flexible conductors.

Tube terminal with narrow palm for multi-stranded (class 5) and stranded (class 2) Cu conductors (acc. to IEC 60228), 70 mm², with an M6 hole in the palm. Used with Elpress certified systems V600, V1300, V250.

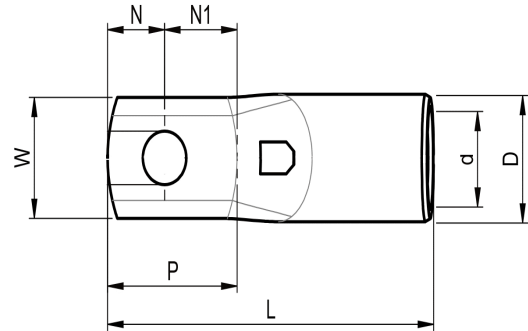

Item number: **7301-290400**

EAN: **7393487061965**

W (mm): **17**

N (mm): **11**

N1 (mm): **12.5**

P (mm): **23.5**

f (mm): **1**

d (mm): **13**

D (mm): **17**

L (mm): **58**

t (mm) - palm thickness: **4.5**

s (mm) - strip length: **22**

Screw: **M6**

Inspection hole: **Yes**

AWG/MCM Cu: **2/0 AWG**

mm² Cu: **70**

ELPRESS