

KRF tube terminals with two holes

KRF300A- 12X2-40

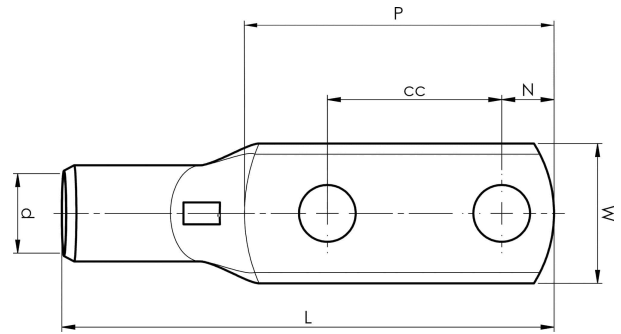

- ✓ Material: Cu 99.95%, tin plated Cu/Sn.
- ✓ Inspection hole.
- ✓ For stranded (class 2) and multi-stranded (class 5) Cu conductors, for multi-stranded Cu conductors contact crimping using the Dual system is recommended.
- ✓ UL-approved, DNV approved.

Example of marking KRF: 17 (neck) Elpress logotype 70 10F (palm)

17 = Die No. 70 = mm² 10 = palm hole for M10 F = type KRF for stranded and flexible conductors.
2 holed tube terminal for multi-stranded (class 5) and stranded (class 2) Cu-conductors (acc. to IEC 60228), 300 mm², with two M12 holes in the palm.
Used with Elpress certified systems V1300 or V250.



**UK
CA**

Item number: **7301-240900**
EAN: **7393487043190**

W (mm): **46**
N (mm): **12**
N1 (mm): **22**
P (mm): **74**
cc (mm): **40**
f (mm): **1.75**
d (mm): **24.5**
D (mm): **31,5**
L (mm): **133**
t (mm) - palm thickness: **6.8**
s (mm) - strip length: **40**

Screw: **M12x2**
Inspection hole: **Yes**

AWG/MCM Cu: **550 MCM**
mm² Cu: **300**

ELPRESS