

Tube terminals 0.75 - 10 mm²

KR4-6

- ✓ Material: Cu 99.95%, tin plated Cu/Sn.
- ✓ For multi-stranded (class 5) and stranded (class 2) Cu conductors.
- ✓ UL approved.
- ✓ With inspection holes.

Examples of palm marking KR: 10-10

10 = mm² 10 = Palm hole for M10

Tube terminal for multi-stranded (class 5) and stranded (class 2) Cu-conductors (acc. to IEC 60228), 4 mm², with an M6 hole in the palm. Used with certified tool GWB4099 or ES2258.

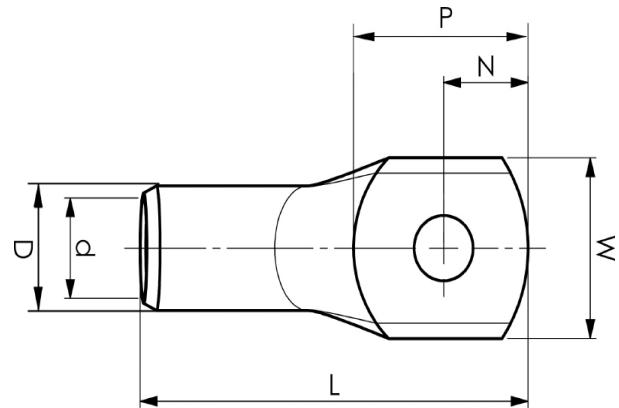

Item number: **7301-011200**

EAN: **7393487005839**

W (mm): **9.9**

N (mm): **5**

N1 (mm): **7**

P (mm): **12**

d (mm): **3**

D (mm): **5**

L (mm): **23**

t (mm) - palm thickness: **1.3**

s (mm) - strip length: **8.5**

Screw: **M6**

Inspection hole: **Yes**

AWG/MCM Cu: **12 AWG**

mm² Cu: **4**