

KRT tube terminals 10 - 500 mm²

KRT35-8

- ✓ Material: Cu 99.95%, tin plated Cu/Sn.
- ✓ Inspection hole.
- ✓ For stranded (class 2) Cu conductors.

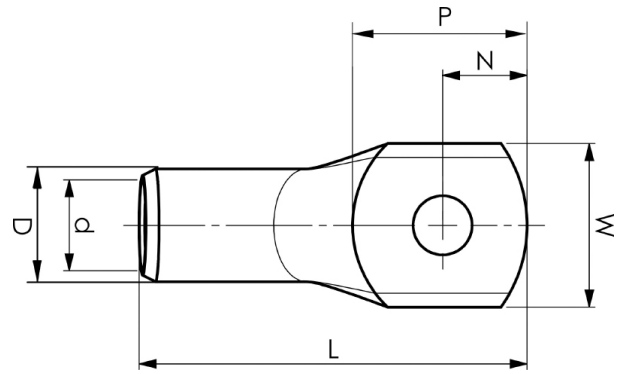

Example of marking KRT: 16 (neck) Elpress logotype 70 10 (palm)

16 = Die No. 70 = mm² 10 = palm hole for M10

Tube terminal type KRT for stranded (class 2) Cu conductors, 35 mm², with an M8 hole in the palm.

Used with Elpress certified systems V600, V1300 or V250.



Item number: **7301-276600**

EAN: **7393487007512**

W (mm): **17**

N (mm): **9.5**

N1 (mm): **11.5**

P (mm): **21**

d (mm): **8.5**

D (mm): **12**

L (mm): **49**

t (mm) - palm thickness: **3.4**

s (mm) - strip length: **20**

Screw: **M8**

Inspection hole: **Yes**

AWG/MCM Cu: **2 AWG**

mm² Cu: **35**