

KRF tube terminals 16 - 800 mm<sup>2</sup>

# KRF300A-12

- ✓ Material: Cu 99.95%, tin plated Cu/Sn.
- ✓ With inspection holes.
- ✓ For stranded (class 2), multi-stranded (class 5) and very flexible (class 6) Cu conductors according to IEC 60228, for multi-stranded Cu conductors contact crimping using the Dual system is recommended.



## Example of marking KRF: 17 (neck) Elpress logotype 70 10F (palm)

17 = Die No. 70 = mm<sup>2</sup> 10 = palm hole for M10 F = type KRF for stranded, flexible and very flexible conductors.

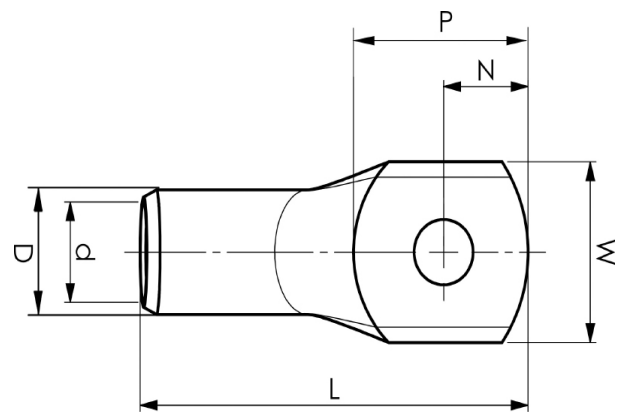

Item number: **7301-146300**  
EAN: **7393487030220**

W (mm): **46**  
N (mm): **15**  
N1 (mm): **19**  
P (mm): **34**  
f (mm): **1.75**  
d (mm): **24.5**  
D (mm): **31,5**  
L (mm): **93**  
t (mm) - palm thickness: **6.8**  
s (mm) - strip length: **40**

Screw: **M12**  
Inspection hole: **Yes**

AWG/MCM Cu: **550 MCM**  
mm<sup>2</sup> Cu: **300**

**ELPRESS**