

KRD tube terminals 16 - 1000 mm²

KRD95-8

- ✓ Material: Cu 99.95%, tin plated Cu/Sn.
- ✓ Inspection hole.
- ✓ For stranded (class 2) Cu conductors.

Example of marking KRD: 14 (neck) Elpress logotype 70 10 (palm)

14 = Die No. 70 = mm² 10 = palm hole for M10
Tube terminal type KRD for stranded (class 2) Cu
conductors, 95 mm², with an M8 hole in the palm.
Used with Elpress certified systems V600, V1300 or
V250.

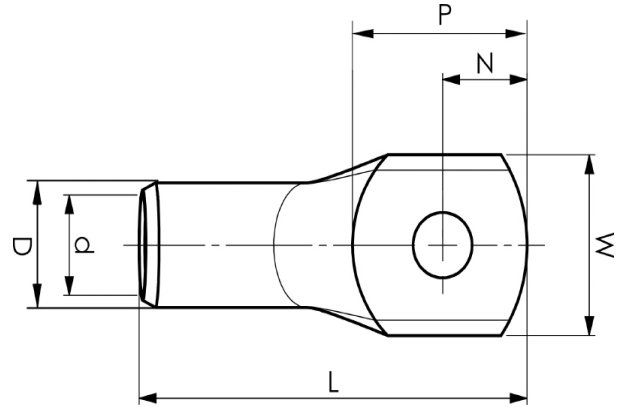

Item number: **7301-103400**
EAN: **7393487006928**

W (mm): **24**
N (mm): **11**
N1 (mm): **11**
P (mm): **22**
f (mm): **1**
d (mm): **13**
D (mm): **16**
L (mm): **58**
t (mm) - palm thickness: **2.9**
s (mm) - strip length: **26**

Screw: **M8**
Inspection hole: **Yes**

AWG/MCM Cu: **3/0 AWG**
mm² Cu: **95**