

KRD tube terminals 16 - 1000 mm²

KRD500-00

- ✓ Material: Cu 99.95%, tin plated Cu/Sn.
- ✓ Inspection hole.
- ✓ For stranded (class 2) Cu conductors.

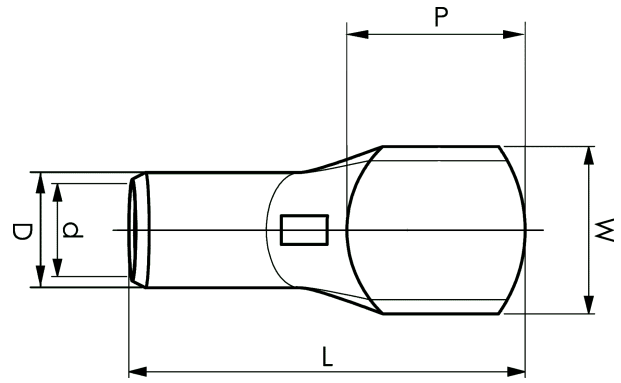

Example of marking KRD: 14 (neck) Elpress logotype 70 10 (palm)

14 = Die No. 70 = mm² 10 = palm hole for M10
Tube terminal type KRD for stranded (class 2) Cu conductors, 500 mm², without a hole in the palm.
Used with Elpress certified systems V250 or V1470.



Item number: **7301-221000**

EAN: **7393487011694**

W (mm): **58**

P (mm): **70**

f (mm): **2.5**

d (mm): **31**

D (mm): **40**

L (mm): **160**

t (mm) - palm thickness: **8.8**

s (mm) - strip length: **70**

Inspection hole: **Yes**

AWG/MCM Cu: **950 MCM**

mm² Cu: **500**