

Aluminium-copper terminals 16 - 1200 mm²

AKK400-16

- ✓ Used for connection of Al conductors for apparatus outlets and busbars of Cu.
- ✓ Two crimps are needed.

AlCu terminal for stranded Al cable 400 mm², with an M16 hole in the palm. Used with Elpress certified system V250.

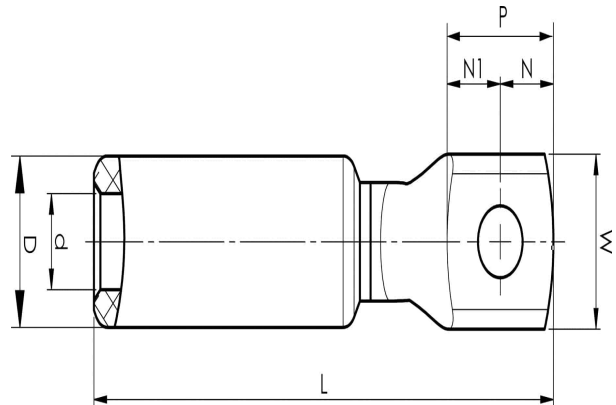

Item number: **7331-404800**

EAN: **7393487009585**

W (mm): **37**

N (mm): **18.5**

N1 (mm): **18.5**

P (mm): **37**

d (mm): **25**

D (mm): **40**

L (mm): **155**

t (mm) - palm thickness: **6.5**

s (mm) - strip length: **83**

Screw: **M16**

AWG/MCM Stranded Al: **700 MCM**

mm² Stranded Al: **400**